



RD - 122

RACK MOUNT DIMMER

OWNERS MANUAL



VERSION 1.3

03/09/2011

TABLE OF CONTENTS

UNIT DESCRIPTION AND FUNCTIONS	3
POWER REQUIREMENTS	3
INSTALLATION	3
PLACEMENT	3
POWER CONNECTIONS	3
OUTPUT CHANNEL CONNECTIONS	4
CONTROL SIGNAL CONNECTIONS	4
SETUP	4
STATUS DISPLAY AND OPERATOR CONTROLS	4
RESETTING THE UNIT	5
ASSIGNING DIMMER CHANNELS	5
TO SET CHANNELS TO DIM OR NON-DIM	5
MANUAL OPERATION	5
NORMAL OPERATION	6
INTERNAL SCENE OPERATION	6
TO SAVE A SCENE	6
TO ACTIVATE A STORED SCENE	6
NOTES ABOUT INTERNAL SCENE	7
CHASER OPERATION	7
ACTIVATING A CHASE PATTERN	7
SELECTING A CHASE PATTERN	7
CONTROLLING CHASER CHARACTERISTICS	8
STRUCTURE OF THE MENU SYSTEM	9
CREATING YOUR OWN CUSTOM CHASE PATTERN	10
TO SAVE A CHASE STEP	10
MAINTENANCE AND REPAIR	11
TROUBLESHOOTING	11
OWNER MAINTENANCE	11
OPERATING AND MAINTENANCE ASSISTANCE	11
CONTROL SIGNAL CONNECTIONS DIAGRAMS	12
PIN ASSIGNMENTS OF CONTROL SIGNAL CONNECTORS	13
WARRANTY	14

RD - 122 RACK MOUNT DIMMER

OWNERS MANUAL

Version 1.3

03/09/2011

UNIT DESCRIPTION AND FUNCTIONS

The RD-122 is a 28,800 Watt, 12 channel, rack mountable lighting dimmer. Each of the channels has a capacity of 2400 Watts. It is controlled via low voltage signals which may be LMX-128 (3 wire multiplex), or USITT DMX-512. The unit is fan cooled. Channels may be independently assigned from the unit. The unit is over temperature and over voltage protected and has a magnetic circuit breaker for each channel. There are several options for channel output connection panels. Options include: Edison plug, External Terminal Strip, Patch Panel, and Socapex Connector panel. The RD-122 has several stand alone functions which enable it to operate without a control console. These functions include a storable scene which may be activated by an external switch closure, a programmable chaser, and 7 factory set chase patterns.

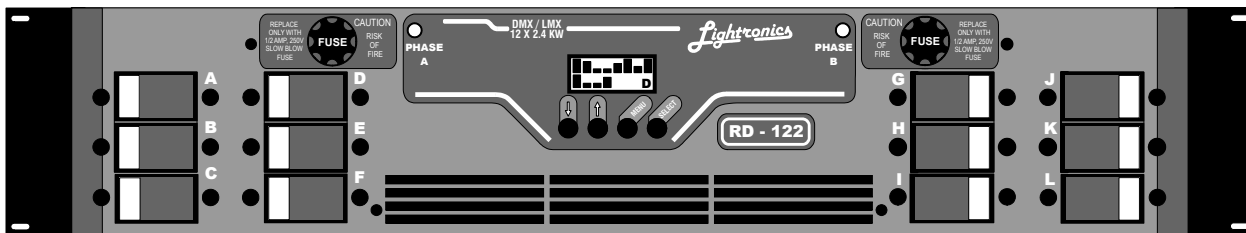

POWER REQUIREMENTS

Each RD-122 requires both hots from a SINGLE PHASE 120/240 VOLT AC or TWO PHASES OF A THREE PHASE 120/208 VOLT AC service. The neutral conductor is shared by two hots so it is important that the two hots used are of different phases. EACH PHASE must be capable of providing 120 AMPS. Line frequency is typically 60HZ. A 50HZ model is available for export. Refer to the dimmer electrical rating markings to determine the operating frequency. One or more RD-122 dimmers may be installed into a standard 19" equipment rack with provisions for connection to an appropriate electrical service in accordance with the National Electrical Code.

INSTALLATION

PLACEMENT

The RD-122 is designed to be mounted in a standard 19" equipment rack using the four mounting holes in the face plate of the dimmer. If the dimming system will be used for touring shows, it is recommended that you provide additional support for the rear of the unit. The dimmer is fan cooled and requires no space between units when multiple dimmers are used. Air enters the dimmer through slots on the side and exits through holes in the bottom of the face plate. Make certain these ventilation holes are not obstructed. Do not place the RD-122 where it will be exposed to moisture or excessive heat. The RD-122 is intended for INDOOR USE ONLY.

POWER CONNECTIONS

Make certain power is removed from the circuits before you begin installation of the dimmer. Consult your local electrical codes to determine the proper wire type and wiring methods for your installation.

Power enters the RD-122 through a knockout sized hole at the rear of the unit. Remove the top cover and install an appropriate cable clamp in the knockout hole. Pass the power cables through the hole. Behind the hole is a terminal block with three lugs. The connections labeled "H1" and "H2" are the line or "hots". The center connection labeled "N" is the neutral. There is an additional lug labeled "G" to the right of the terminal block. This is for connecting the unit to earth ground. When connections are completed, reinstall the cover and tighten the cable clamp.

RD - 122 RACK MOUNT DIMMER
OWNERS MANUAL

Version 1.3

03/09/2011

OUTPUT CHANNEL CONNECTIONS

The RD-122 can be supplied with one of several rear panel output options. Channel output connections are according to the rear panel selected. Channel connections generally proceed from left to right (if you are facing the rear of the unit). Channel "A" will be on the left end. On a unit supplied with edison plug outlets channels A - F are on the top row (from left to right). Channels G - L are on the lower row (from left to right). Connections for load Neutrals are provided. There is also a ground lug terminal to be used for your load circuits grounds.

CONTROL SIGNAL CONNECTIONS

A control signal enters the RD-122 through connectors on the rear of the unit. If you are using the 3 pin multiplex protocol ("LMX" or compatible), plug the control cable into the 3 pin "XLR" connector. If you are using the DMX-512 protocol, plug your 5 pin DMX control cable into the 5 pin to 9 pin adapter supplied with the RD-122 and plug the 9 pin connector into the upper 9 pin connector on the rear of the dimmer. In either case, the lower 9 pin connector and the ribbon cable jumper that is supplied can be used to connect from the lower connector of the first dimmer into the upper connector of the next dimmer and so on. See the included drawings at the back of this manual for clarification. The RD-122 is shipped with the power supply set to provide +15 volts DC console power when using the 3 pin multiplex protocol. Note that the DMX-512 protocol does NOT provide a means for console power via the control cable. Systems using the DMX protocol must have console power supplied by other means.

SETUP

The RD-122 has a front panel LCD display and operator controls. The display indicates dimmer status information and is used with the operator control buttons to set up and monitor dimmer operation. A menu system is used to access the various features of the RD-122. During normal dimmer operation the display shows the current intensity setting for each channel and indicates what type of dimmer control is in affect. This is called the STATUS DISPLAY and is shown in the diagram below.

STATUS DISPLAY AND OPERATOR CONTROLS

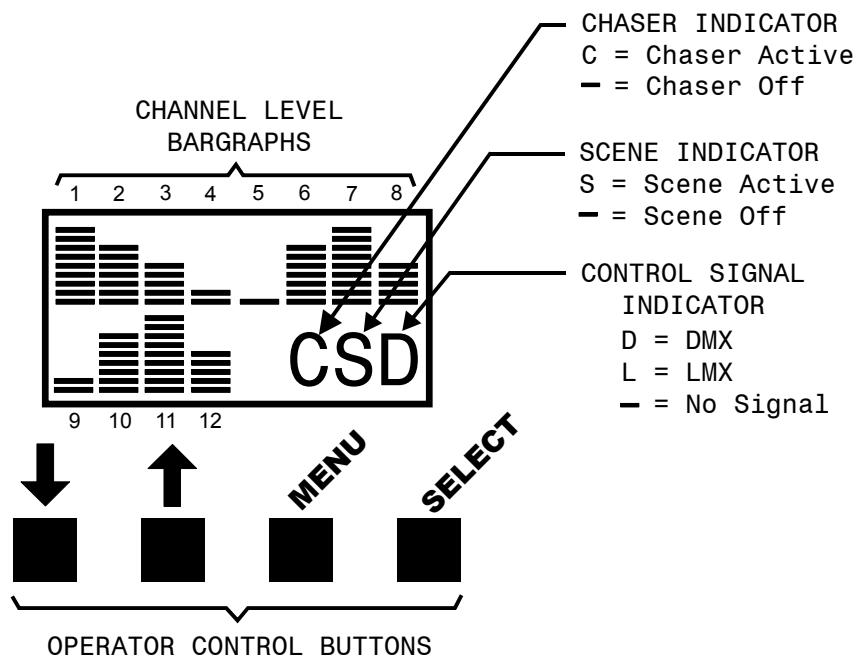

**RD - 122 RACK MOUNT DIMMER
OWNERS MANUAL**

Version 1.3

03/09/2011

RESETTING THE UNIT

The RD-122 may be reset to a "factory provided" configuration by holding down the **MENU** button on the front panel for about 5 seconds. A message "SYSTEM RESET" will appear on the front panel LCD display. Release the **MENU** button when you see the message. Resetting the unit causes the following actions:

1. Channel patch is set to 1 to 1.
2. All channels are set to DIM (relay mode turned off).
3. The external switch sensing function is turned off.
4. The internally stored scene is turned off. (it is not erased).
5. The programmable chase pattern is turned off and erased.
6. Chase parameters are set to a default set of conditions. The Default conditions are given in the table under the section CONTROLLING CHASER CHARACTERISTICS.

You should perform a setup procedure before using the unit. Setup includes (1) Setting the channel assignments that the dimmer will respond to and (2) Setting individual channels to "DIM" or "NON-DIM" (relay). Once the setup is completed the unit will retain the settings until changed by the operator (including when the unit is powered off and restarted).

ASSIGNING DIMMER CHANNELS (CHANNEL PATCHING)

The RD-122 has 12 dimming channels labeled A-L. Each of these channels may be assigned to any console channel number from 1 to 512. Multiple dimmer channels may be assigned to a single console fader if desired. This gives you the ability to soft patch at the dimmer itself.

TO ASSIGN DIMMER CHANNELS:

1. Press the **MENU** once to enter the patch mode. The display will indicate "PTCH".
2. Push **SELECT**. The left display bargraph channel (for dimmer channel A) will flash and the currently assigned console channel will be shown on the display bottom row. Use the **UP** and **DOWN** arrow buttons to change the console channel assignment for channel A.
3. Push **SELECT** to advance to the next dimmer channel. Continue to assign channels through channel L.
4. Push **MENU** three times to return to the normal operation mode.

TO SET CHANNELS TO DIM OR NON-DIM (RELAY):

1. Press **MENU** twice. The LCD display will indicate "NDIM".
2. Push **SELECT**. The left display bargraph channel (for dimmer channel A) will flash. The display will show "DMR" or "RLY" on the bottom row according to the current setting.
3. Use the **UP** and **DOWN** arrow buttons to change between dim and relay modes for that channel.
4. Push **SELECT** to advance to the next dimmer channel. Continue to set channels through channel L.
5. Press **MENU** twice to return to the normal display.

MANUAL OPERATION

Dimmer channels can be operated manually from the dimmer front panel. Press the **SELECT** button until the desired channel's "bar graph" is flashing. Press the **UP** or **DOWN** arrow buttons until the desired level is reached. Press the **SELECT** button to advance to other channels. To return control to your console, press the **SELECT** button until you go PAST the last channel and stop. After approximately 6 seconds the dimmer will return to console control. A channel continues to respond to console settings when operating from the front panel unless you change the level for that channel at the dimmer front panel. Once this occurs - that channel will NOT respond to console settings until you return to normal console control.

RD - 122 RACK MOUNT DIMMER OWNERS MANUAL

Version 1.3

03/09/2011

NORMAL OPERATION

As you operate faders on your console the associated channel levels are indicated on the RD-122 display. The display will also indicate any abnormal conditions such as over temperature or over voltage. The fan will run at full speed whenever there is a control signal present and one or more faders are at full on. The fan will drop to half speed a few minutes after all faders are lowered to full off and will stop shortly after the control signal is removed.

INTERNAL SCENE OPERATION

The RD-122 has the ability to internally save a single scene which may be activated remotely. The scene remains in the unit's memory when it is shut off and will be available the next time the unit is powered on. A saved scene is not lost when the unit is reset.

TO SAVE A SCENE:

1. Create the scene from a control console or from the front panel of the dimmer itself by activating the applicable channels.
2. Press and hold the front panel **SELECT** button until you see the front panel display appears as shown below: You will have to hold the button down for about 6 seconds.

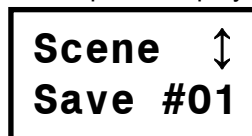

Scene ↑
Save #01

3. Push **SELECT**. The display will show the message:



SAVING
NOW !

4. The scene has been recorded when the LCD reverts to its normal display.

TO ACTIVATE A STORED SCENE:

A scene previously stored in the RD-122 is activated by connecting together pins 5 and 9 of either DB9 connector. The DB9 connectors are on the rear of the dimmer. This may be done via a remotely located switch. The activated scene will remain active as long as pins 5 and 9 on the DB9 connectors remain connected together.

In addition to activating a scene, the RD-122 can be set to ignore the remote switch or activate chaser functions. In order to use the remote switch for internal scene activation you must enable that function as follows:

1. Push **MENU** 3 times. The display will show the message "MENU" on the bottom row.
2. Push **SELECT**. The LCD will display one of messages shown below.



Input1 ↑
Scene



Input1 ↑
Chaser



Input1 ↑
Not Used

3. If "Not Used" or "Chaser" appears on the bottom row, push the **UP** or **DOWN** until "Scene" appears.
4. Push **SELECT** to return the unit to normal operation.

The front panel display shows an "S" on the bottom row as an indication that an internal scene is active.

RD - 122 RACK MOUNT DIMMER OWNERS MANUAL

Version 1.3

03/09/2011

NOTES ABOUT INTERNAL SCENE:

The RD-122 continues to respond to control console signals when the internal scene is activated. The intensity of any given channel will be the "greatest of" or "pile on" result of the internal scene and console level setting.

If multiple RD series dimmers are connected as a system (See CONTROL SIGNAL CONNECTIONS), then a remote switch connected to the system can activate system wide scenes or only scenes in specific dimmers depending on how the remote switch function is set in each dimmer. These scene features give you the ability to use the dimmer for house lights and other applications where it is not practical to operate a control console.

CHASER OPERATION

The RD-122 can operate chaser functions as a "stand alone" unit with no control console present. There are 7 factory set chase patterns embedded in the unit software. There is also one pattern which may be programmed by the user. The chase step rate, chase step fade rate, and chase intensity can be set by the user for all chaser functions. Chaser functions may be set to run continuously or as a single occurrence. The number of steps (up to 32) can be set for the programmable chase. The RD-122 may be set to begin chaser functions at "power up" or in response to a remote switch. A bounce option can be imposed on a chase pattern. This results in a pattern which runs in its normal sequence then runs the same sequence backwards.

ACTIVATING A CHASE PATTERN

A chase stored in the RD-122 is activated by connecting together pins 5 and 9 of either DB9 connector. The DB9 connectors are on the rear of the dimmer. This may be done via a remotely located switch. The activated chase will remain active as long as pins 5 and 9 on the DB9 connectors remain connected together.

In addition to activating a chase, the RD-122 can be set to ignore the remote switch or use it to activate a scene. In order to use the remote switch to activate chase patterns you must enable that function as follows:

1. Push **MENU** 3 times. The display will show the message "MENU" on the bottom row.
2. Push **SELECT**. The LCD will display one of messages shown below.



3. If "Not Used" or "Scene" appears on the bottom row, push the **UP** or **DOWN** arrow buttons until "Chaser" appears.
4. Push **SELECT** to return the unit to normal operation.

The Front panel display shows a "C" on the bottom row as an indication that an internal chase is active.

SELECTING A CHASE PATTERN

You can select any of the 7 factory preset chase patterns to run or create and run your own custom pattern. Instructions for creating a custom chase pattern are given further on in this manual.

A chase pattern is selected using the RD-122 menu system as follows:

**RD - 122 RACK MOUNT DIMMER
OWNERS MANUAL**

1. Push MENU 3 times. The LCD will appear as shown:



2. Push SELECT. Then push MENU. The LCD will appear as shown: The bottom display row shows the currently selected pattern. The pattern "4Ch Seq" is shown as an example.



3. Use the UP and DOWN arrow buttons to scroll through the available chase patterns. Push SELECT when the desired pattern appears.

Note: Remember that this action does not activate the chase pattern. This action selects which pattern will be run when activated by the remote switch function.

The available patterns are:

4 CHANNEL SEQUENCE	8 CHANNEL SEQUENCE
4 CHANNEL BUILD	12 CHANNEL SEQUENCE
6 CHANNEL SEQUENCE	RANDOM
6 CHANNEL BUILD	PROGRAMMABLE

CONTROLLING CHASER CHARACTERISTICS

You can control seven characteristics of a chase pattern. These controls are described as follows:

Chase Rate	The duration of each chase step (.25 - 999.75 Sec.). Default = 1 Sec.
Chase Fade Rate	The time for each step to reach maximum intensity (0 - 100% of step time). Default = 100%
Chase Intensity	The overall brightness of the chase (0 - 100%) Default = 100%
Chase Steps	The maximum number of steps in the chase (1 - 32) Default = 4
Chase Bounce	Causes reversal at the end of each sequence (Ignored during RANDOM). Default = Off
Continuous /Single	Enables/Disables a "one shot" chase occurrence (Ignored during RANDOM). Default = Continuous
Activate Chase at power up	Enables chase to begin automatically when dimmer is turned on. ** Default = Off

** Overrides remote switch setting

The default setting is the factory set value.

All of these characteristics can be set via the RD-122 menu system. See the diagram STRUCTURE OF MENU SYSTEM for a complete layout of menu system operation.

**RD - 122 RACK MOUNT DIMMER
OWNERS MANUAL**

Version 1.3

03/09/2011

STRUCTURE OF MENU SYSTEM

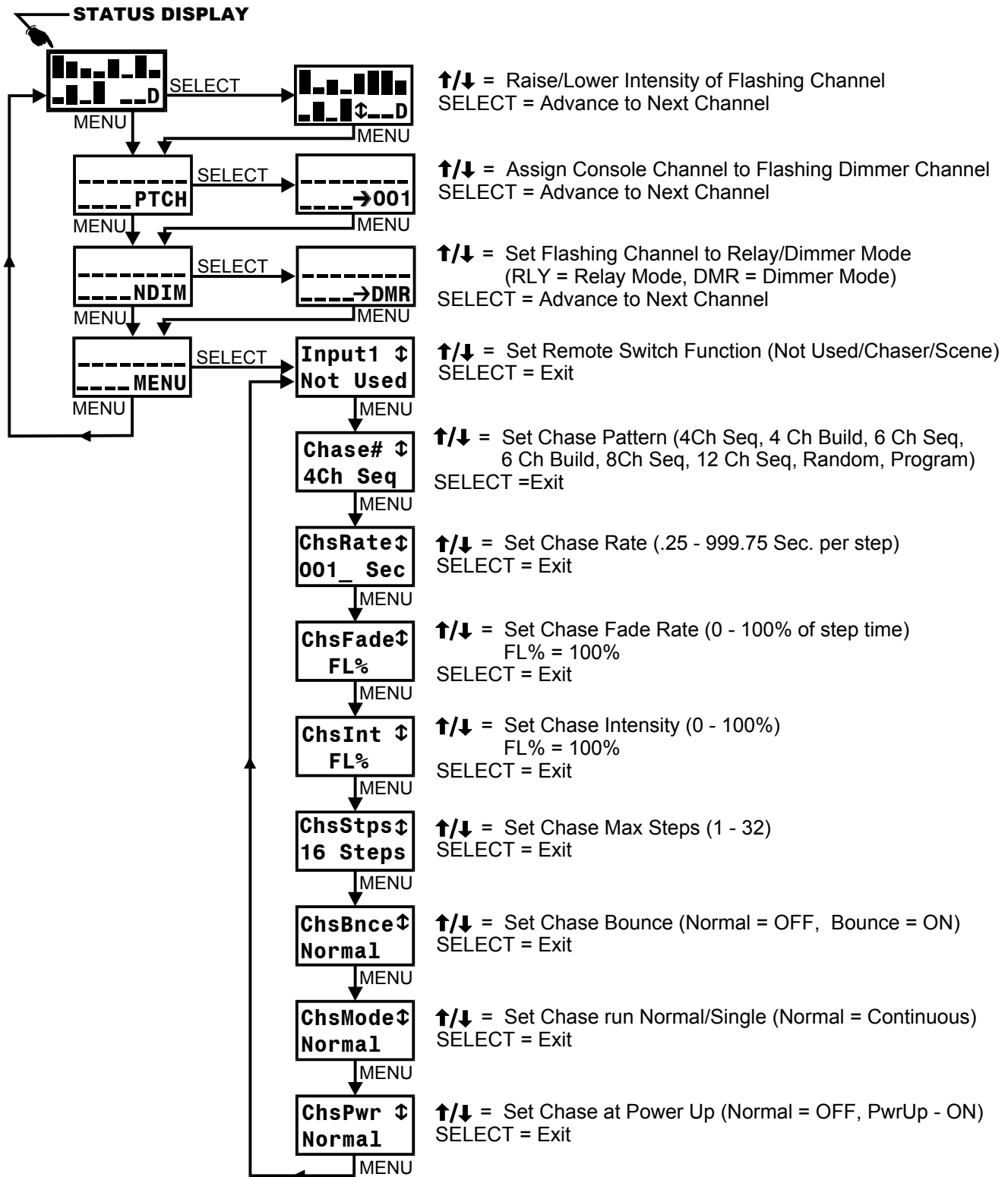

**RD - 122 RACK MOUNT DIMMER
OWNERS MANUAL**

Version 1.3

03/09/2011

CREATING YOUR OWN CUSTOM CHASE PATTERN

The programmable chase pattern is created by setting the intensity for all dimmer channels for each step in the chase. The chase step is then recorded. This action is then repeated for each additional step to be recorded. The channel intensities can be set either from the RD-122 front panel as in manual operation or by using a control console.

TO SAVE A CHASE STEP:

1. Create the step from a control console or from the front panel of the dimmer itself by activating the applicable channels. Channel intensities are recorded as either full ON or full OFF. If you want a given channel to be on for a chase step then the channel must be set to greater than 50 % intensity. Note that the overall intensity of the whole chase pattern may be set using the menu system.
2. Press and hold the front panel **SELECT** button until the front panel display appears as shown below: You will have to hold the button down for about 6 seconds.



Scene ↑
Save #01

3. Push the **UP** arrow button. The display will appear as follows: This is the display for chase step #1. If you want to record to another step number - use the **UP** and **DOWN** arrow buttons to make the correct step number appear on the lower display row.



Chs Stp ↑
Save #01

4. Push **SELECT**. The display will show the message:



SAVING
NOW !

5. The chase step has been recorded when the LCD reverts to its normal STATUS DISPLAY.

The above recording process is repeated for each step in the programmable chase pattern. See the section CONTROLLING CHASER CHARACTERISTICS for information about how the chase can be made to appear when activated.

MAINTENANCE AND REPAIR

TROUBLESHOOTING

VERIFY THAT ALL POWER IS REMOVED FROM THE DIMMER BEFORE HANDLING THE UNIT.

1. To simplify troubleshooting - reset the unit to provide a known set of conditions.
2. Check that the console is powered and that console channels are correctly patched or set.
3. Check the control cable between the dimmer and its console.
4. Verify the loads and their connections.

OWNER MAINTENANCE

There are no user serviceable parts inside the unit.

The best way to prolong the life of your unit is to keep it cool, clean, and dry. It is important that the cooling intake and exit vent holes are clean and unobstructed.

Service by other than Lightronics authorized agents may void your warranty.

OPERATING AND MAINTENANCE ASSISTANCE

If service is required, contact the dealer from whom you purchased the equipment or contact Lightronics, Service Department, 509 Central Drive, Virginia Beach, VA 23454 TEL 757 486 3588.

Lightronics recommends that you record the serial number of your unit for future reference.

SERIAL NUMBER _____

**RD - 122 RACK MOUNT DIMMER
OWNERS MANUAL**

**CONTROL SIGNAL CONNECTIONS
FOR LMX PROTOCOL**

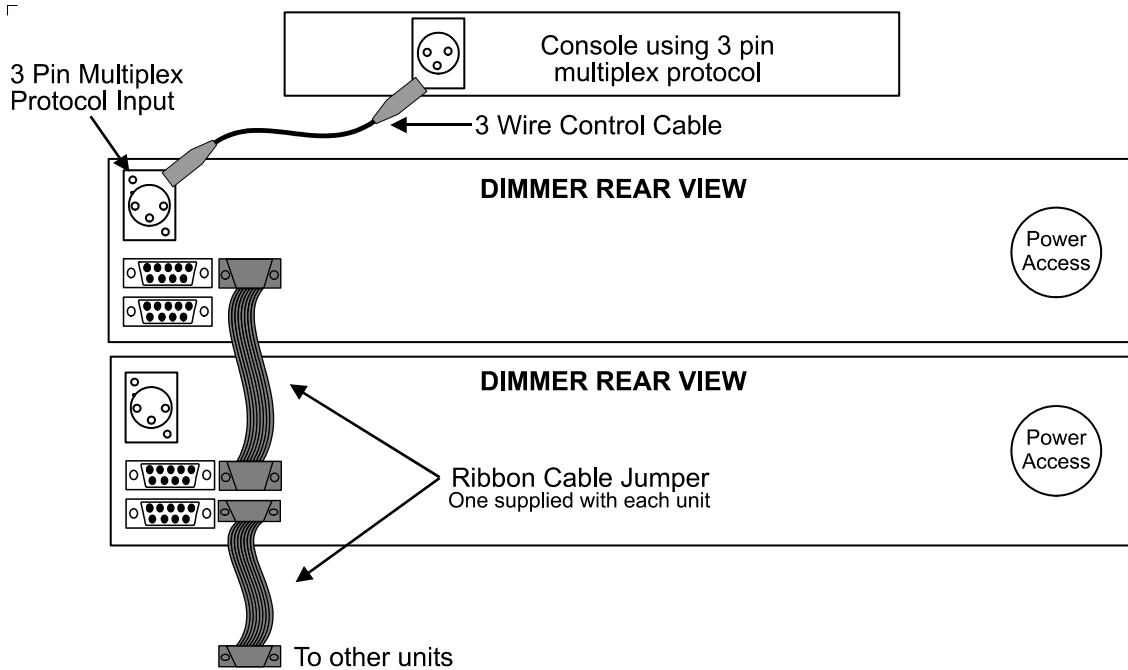

**CONTROL SIGNAL CONNECTIONS
FOR DMX 512 PROTOCOL**

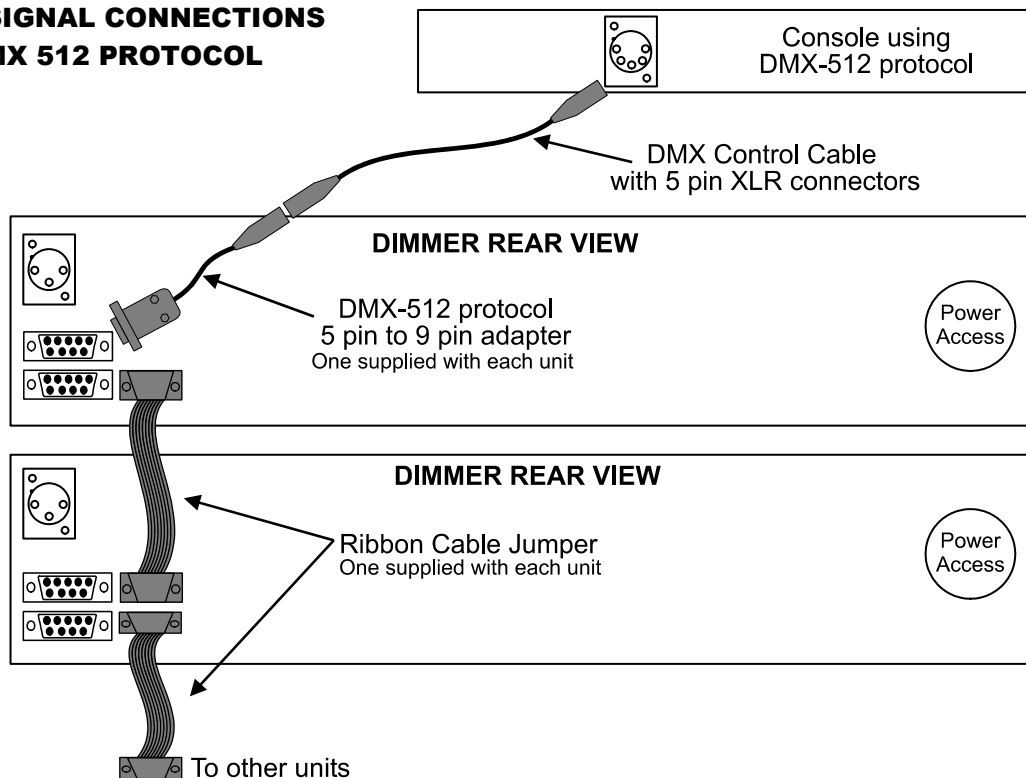

**RD - 122 RACK MOUNT DIMMER
OWNERS MANUAL**

PIN ASSIGNMENTS OF CONTROL SIGNAL CONNECTORS USED ON THE RD-122

MULTIPLEX (LMX) CONNECTOR
3 PIN MALE XLR
Used on rear of chassis

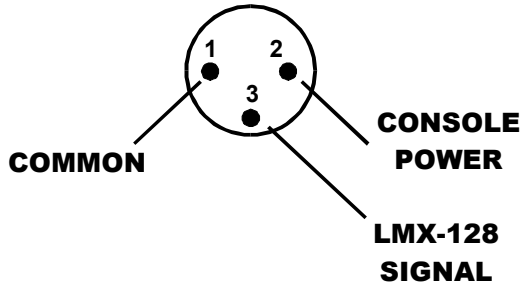

DMX-512 CONNECTOR
5 PIN MALE XLR
Used on adapter cable

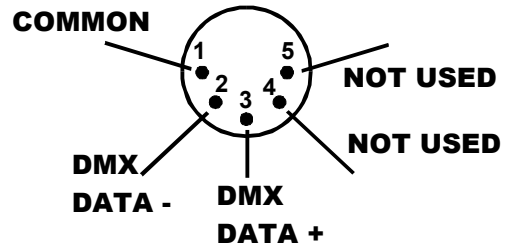

I/O CONNECTOR
9 PIN MALE (DB9)
Used on rear of chassis

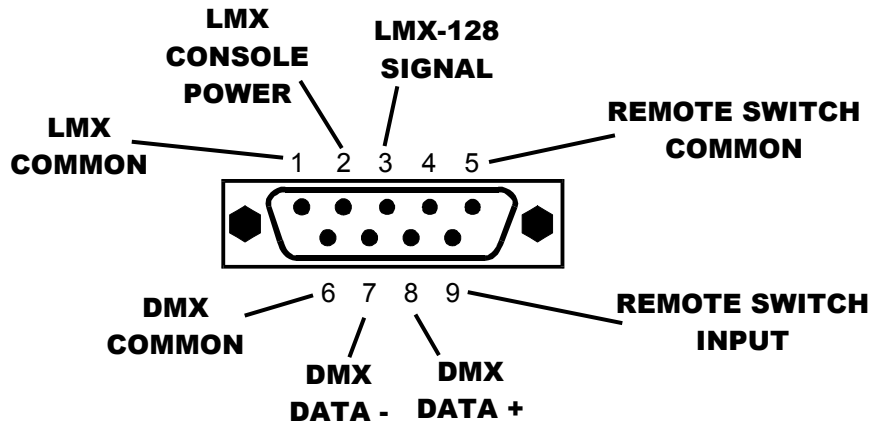

The banner features the Lightronics logo on the left and right, with the word "WARRANTY" in large, bold, white capital letters centered on a dark grey background.

LIGHTRONICS[®] **WARRANTY** LIGHTRONICS[®]

All Lightronics products are warranted for a period of TWO/FIVE YEARS from the date of purchase against defects in materials and workmanship.

This warranty is subject to the following restrictions and conditions:

- A) If service is required, you may be asked to provide proof of purchase from an authorized Lightronics dealer.
- B) The FIVE YEAR WARRANTY is only valid if the warranty card is returned to Lightronics accompanied with a copy of the original receipt of purchase within 30 DAYS of the purchase date, if not then the TWO YEAR WARRANTY applies. Warranty is valid only for the original purchaser of the unit.
- C) This warranty does not apply to damage resulting from abuse, misuse, accidents, shipping, and repairs or modifications by anyone other than an authorized Lightronics service representative.
- D) This warranty is void if the serial number is removed, altered or defaced.
- E) This warranty does not cover loss or damage, direct or indirect arising from the use or inability to use this product.
- F) Lightronics reserves the right to make any changes, modifications, or updates as deemed appropriate by Lightronics to products returned for service. Such changes may be made without prior notification to the user and without incurring any responsibility or liability for modifications or changes to equipment previously supplied. Lightronics is not responsible for supplying new equipment in accordance with any earlier specifications.
- G) This warranty is the only warranty either expressed, implied, or statutory, upon which the equipment is purchased. No representatives, dealers or any of their agents are authorized to make any warranties, guarantees, or representations other than expressly stated herein.
- H) This warranty does not cover the cost of shipping products to or from Lightronics for service.
- I) Lightronics Inc. reserves the right to make changes as deemed necessary to this warranty without prior notification.