

Pathway Connectivity, Modular Receptacles

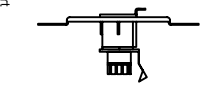

Pinout
5 Pin Male XLR
DMX IN

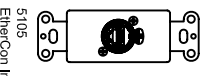
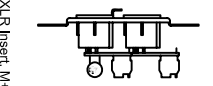
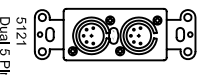
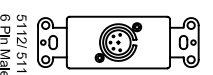
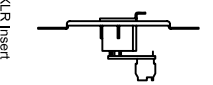
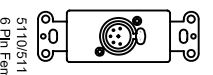
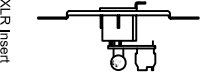
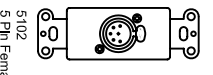
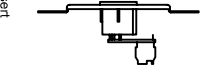
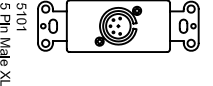
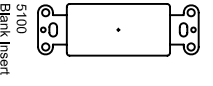
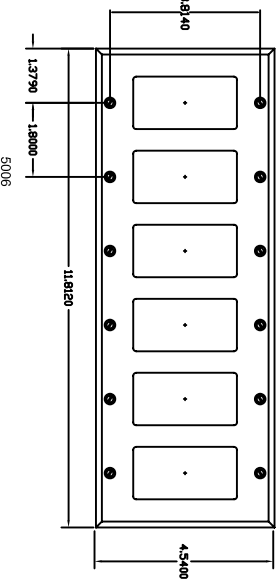
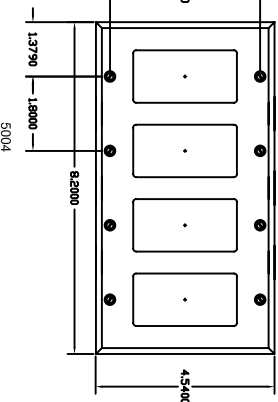
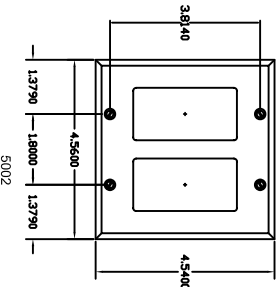
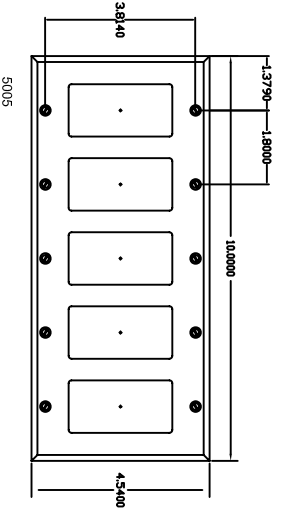
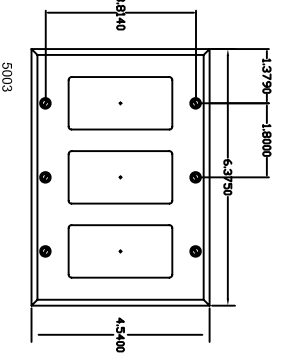
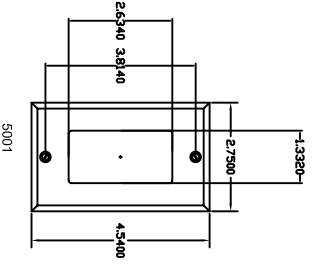
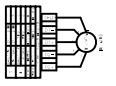

Pinout
5 Pin Female XLR
DMX OUT

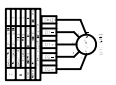

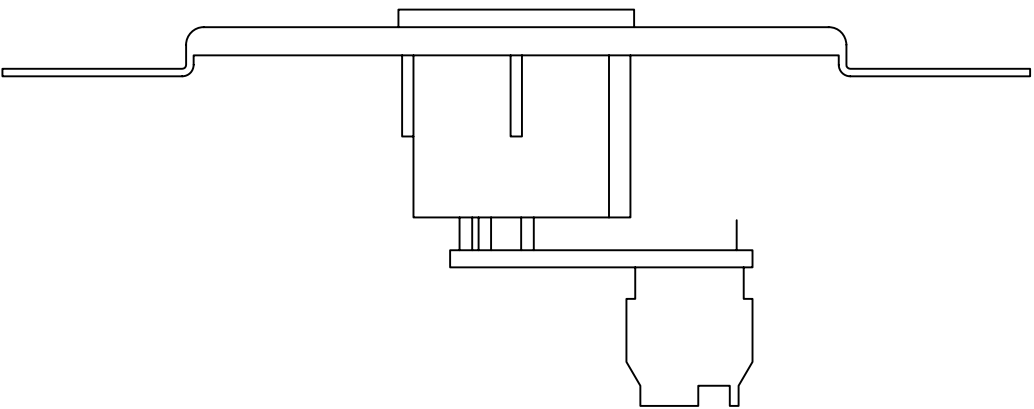
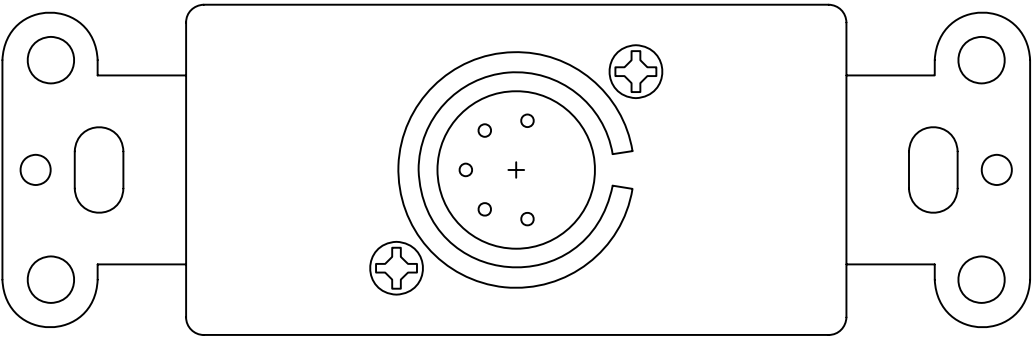

5101 5 Pin Male XLR Insert

FILENAME: PART NUMBER: 5101



Pathway Connectivity Inc.
 480C - 36 Avenue S.E.
 Calgary, Alberta, T2G 1W4, Canada
 Phone: +1(403)243-8110 Fax: +1(403)287-1281
<http://www.pathwayconnect.com>

DRAWN BY:
 DATE:
 CHECKED:
 SCALE: NTS
 UNITS: INCHES

REV

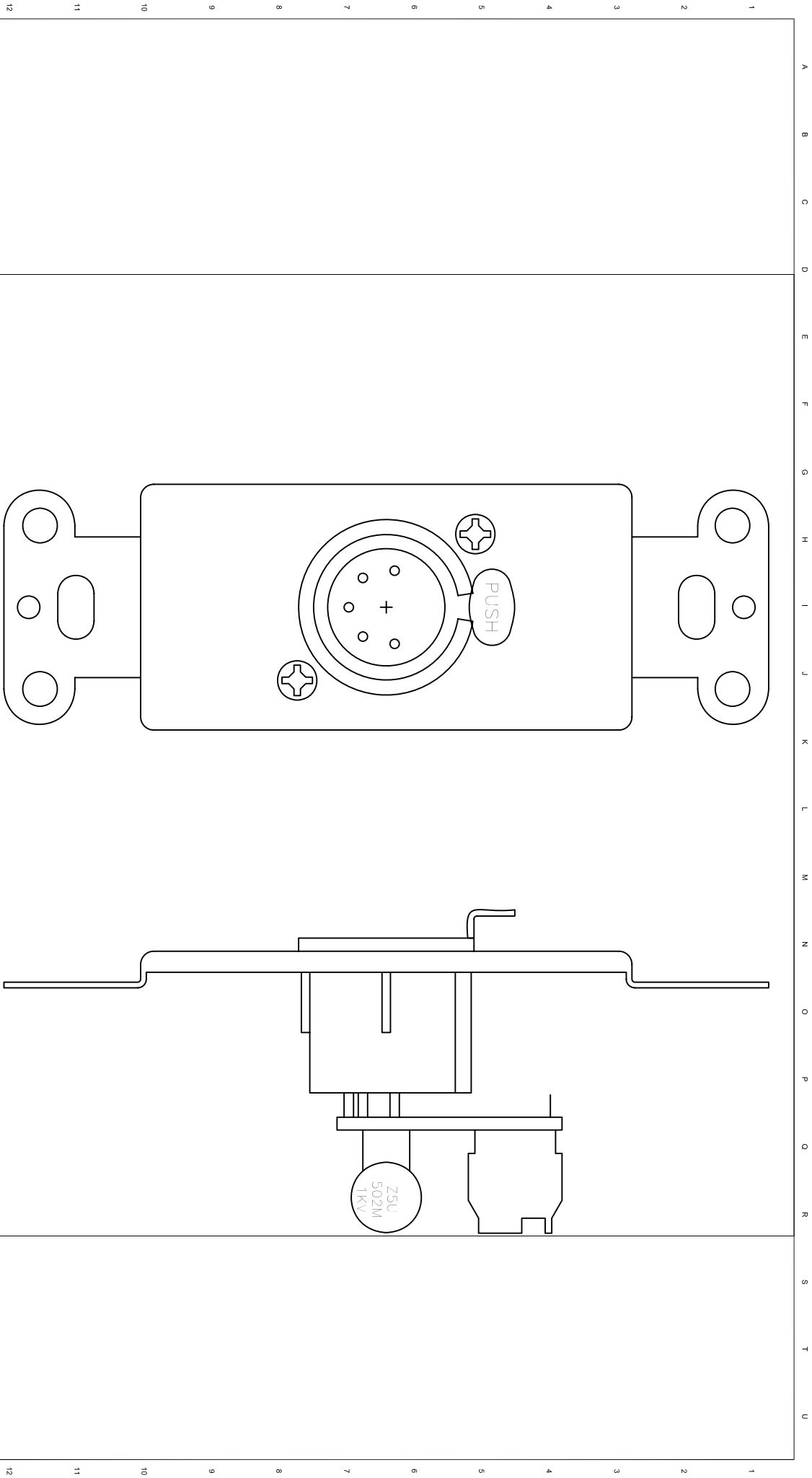

5102 5 Pin Female XLR Insert

FILENAME: PART NUMBER: 5102



Pathway Connectivity Inc.
 480C - 36 Avenue S.E.
 Calgary, Alberta, T2G 1W4, Canada
 Phone: +1(403)243-8110 Fax: +1(403)287-1281
<http://www.pathwayconnect.com>

DRAWN BY:	REV
DATE:	
CHECKED:	
SCALE: NTS	
UNITS: INCHES	

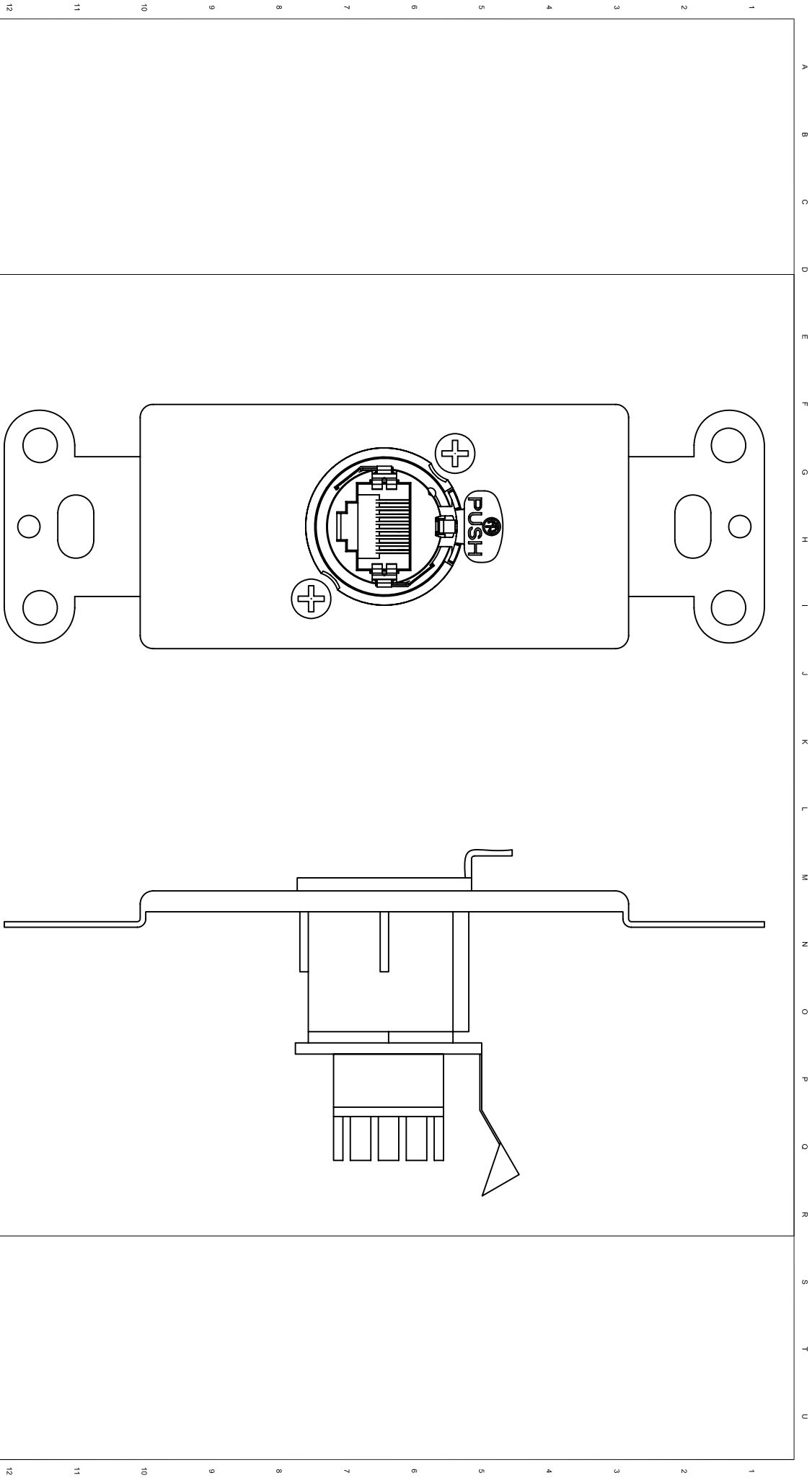

13
 FILENAME: 5105 RJA5 Cat5 Insert
 PART NUMBER: 5105



Pathway Connectivity Inc.
 480C - 36 Avenue S.E.
 Calgary, Alberta, T2G 1W4, Canada
 Phone: +1(403)243-8110 Fax: +1(403)287-1281
<http://www.pathwayconnect.com>

DRAWN BY:
 DATE:
 CHECKED:
 SCALE: NTS
 UNITS: INCHES

REV

A B C D E F G H I J K L M N O P Q R S T U

12 11 10 9 8 7 6 5 4 3 2 1

12 11 10 9 8 7 6 5 4 3 2 1

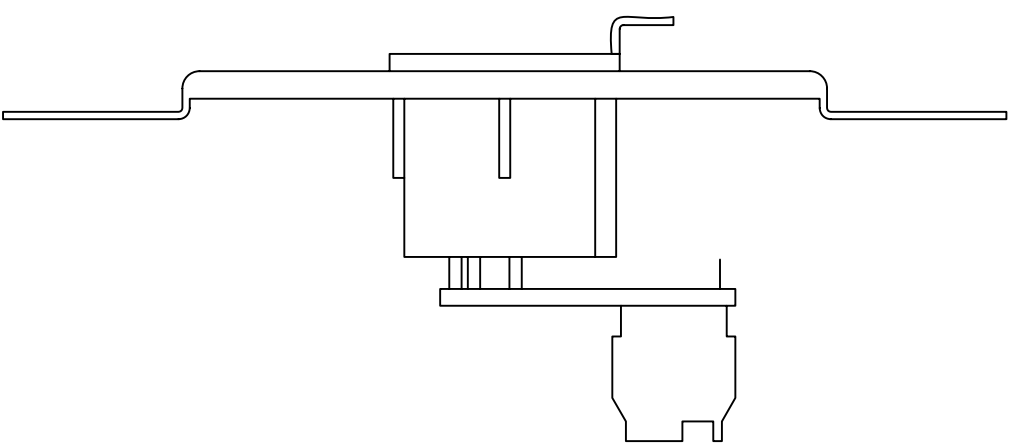
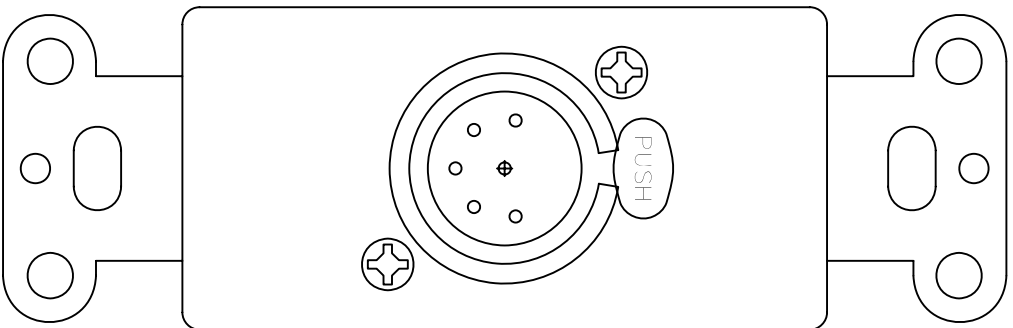

5110/5111 6 Pin Female XLR Insert

FILENAME: PART NUMBER: 5110/5111



Pathway Connectivity Inc.
 480C - 36 Avenue S.E.
 Calgary, Alberta, T2G 1W4, Canada
 Phone: +1(403)243-8110 Fax: +1(403)287-1281
<http://www.pathwayconnect.com>

DRAWN BY:
 DATE:
 CHECKED:
 SCALE: NTS
 UNITS: INCHES

REV

Grid lines: A, B, C, D, E, F, G, H, I, J, K, L, M, N, O, P, Q, R, S, T, U (horizontal)
 1, 2, 3, 4, 5, 6, 7, 8, 9, 10, 11, 12 (vertical)

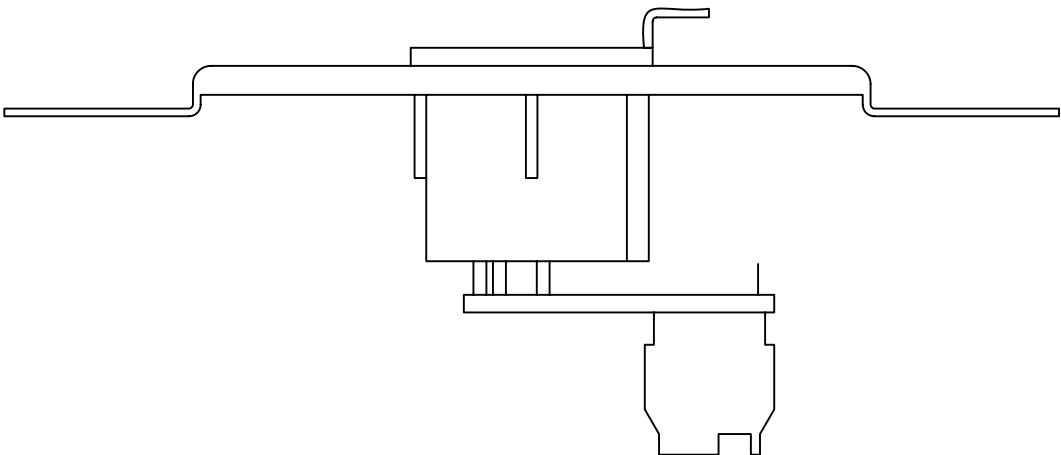
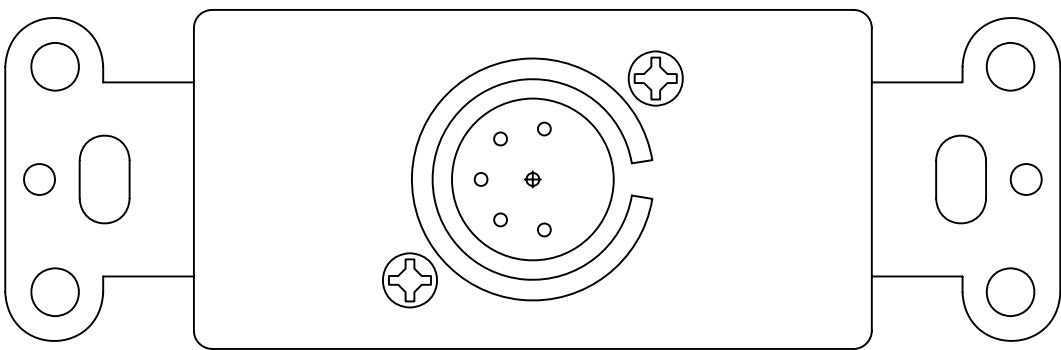

5112/5113 6 Pin Male XLR Insert

FILENAME: PART NUMBER: 51125113



Pathway Connectivity Inc.
 480C - 36 Avenue S.E.
 Calgary, Alberta, T2G 1W4, Canada
 Phone: +1(403)243-8110 Fax: +1(403)287-1281
<http://www.pathwayconnect.com>

DRAWN BY:	
DATE:	
CHECKED:	
SCALE:	NTS
UNITS:	INCHES

REV

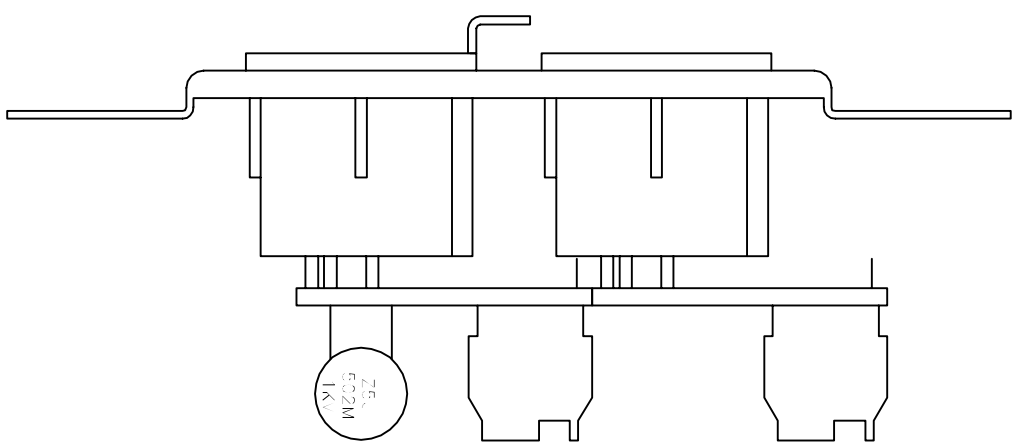
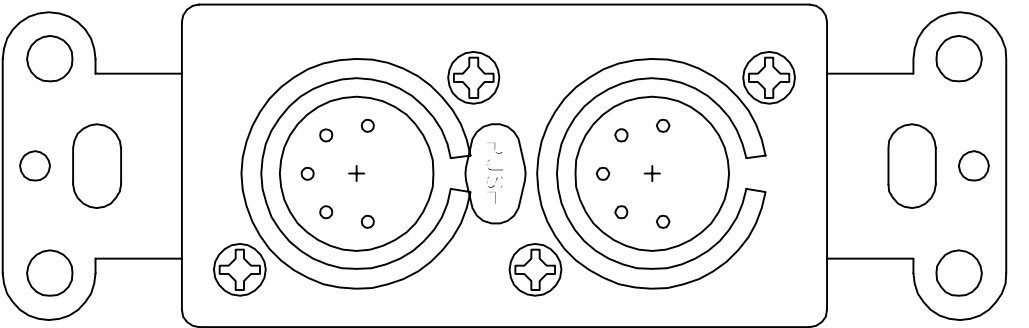

5121 Dual 5 Pin M+F XLR Insert

FILENAME: PART NUMBER: 5121



Pathway Connectivity Inc.
 480C - 36 Avenue S.E.
 Calgary, Alberta, T2G 1W4, Canada
 Phone: +1(403)243-8110 Fax: +1(403)287-1281
<http://www.pathwayconnect.com>

DRAWN BY:	
DATE:	
CHECKED:	
SCALE:	NTS
UNITS:	INCHES

REV

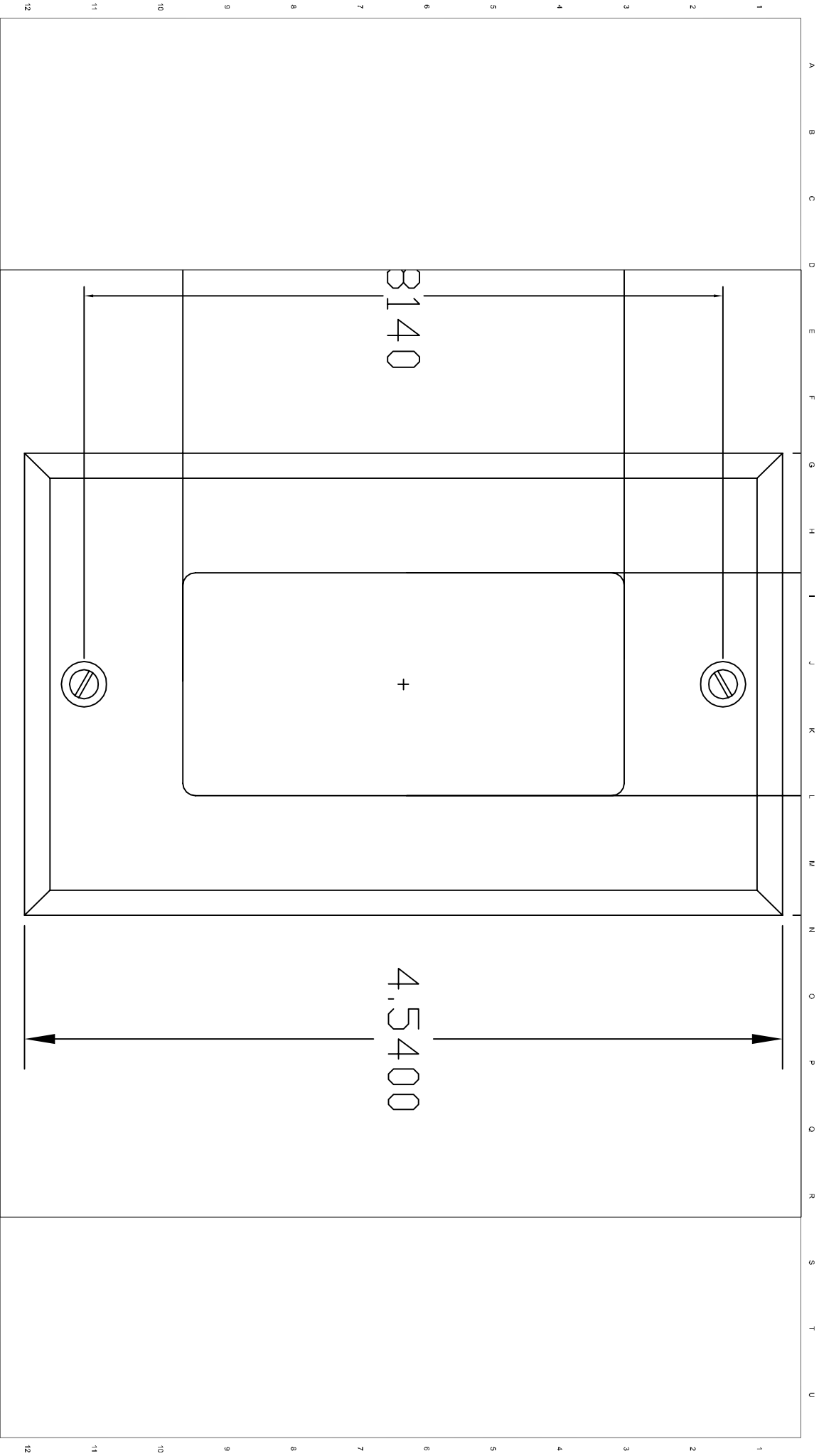

5001 SINGLE GANG FACEPLATE

FILENAME: PART NUMBER: 5001



Pathway Connectivity Inc.
 480C - 36 Avenue S.E.
 Calgary, Alberta, T2G 1W4, Canada
 Phone: +1(403)243-8110 Fax: +1(403)287-1281
<http://www.pathwayconnect.com>

DRAWN BY:	
DATE:	
CHECKED:	
SCALE:	NTS
UNITS:	INCHES

REV

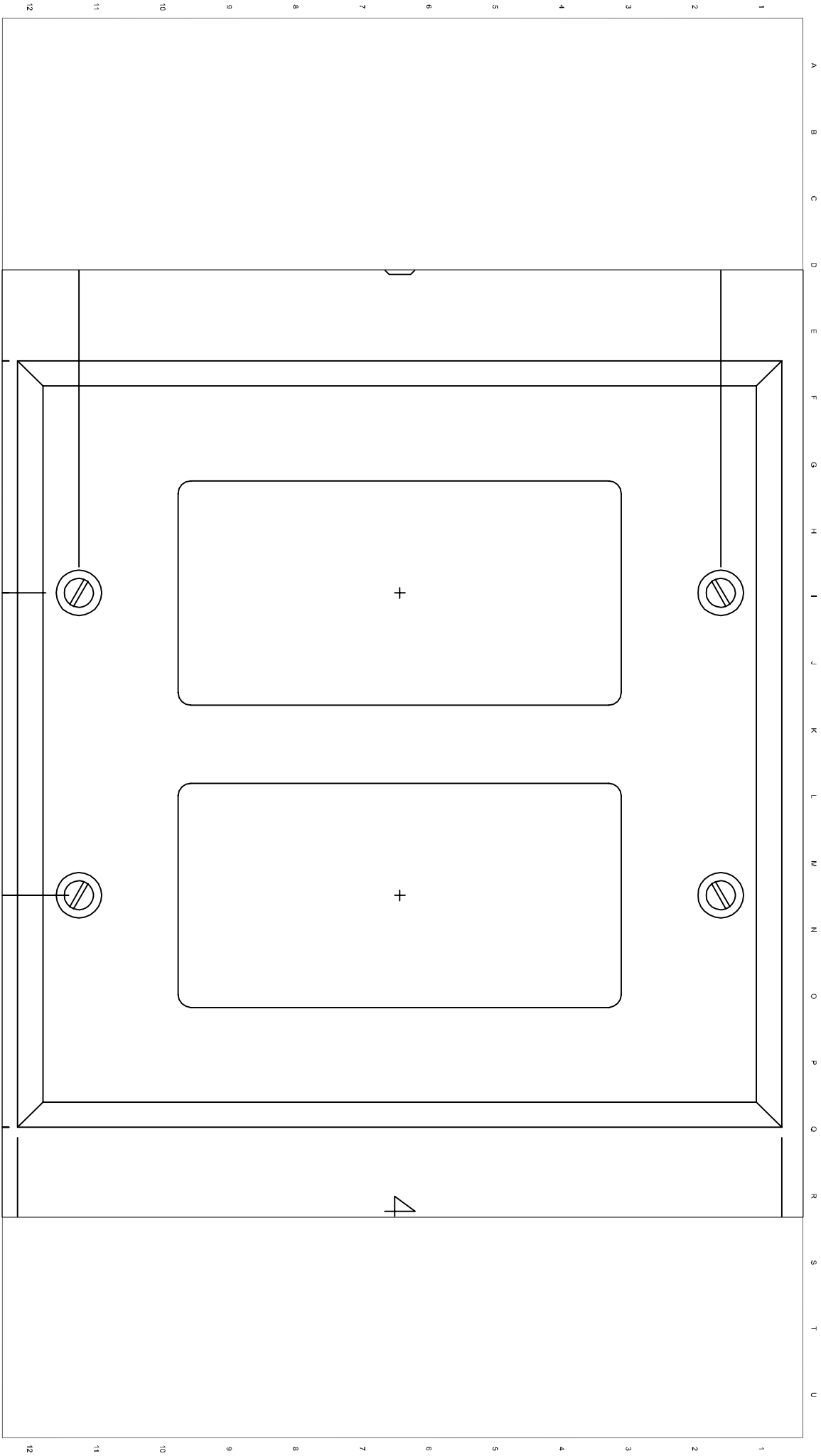

5002 DOUBLE GANG FACEPLATE

FILENAME: PART NUMBER: 5002



Pathway Connectivity Inc.
 480C - 36 Avenue S.E.
 Calgary, Alberta, T2G 1W4, Canada
 Phone: +1(403)243-8110 Fax: +1(403)287-1281
<http://www.pathwayconnect.com>

DRAWN BY:	
DATE:	
CHECKED:	
SCALE:	NTS
UNITS:	INCHES

REV

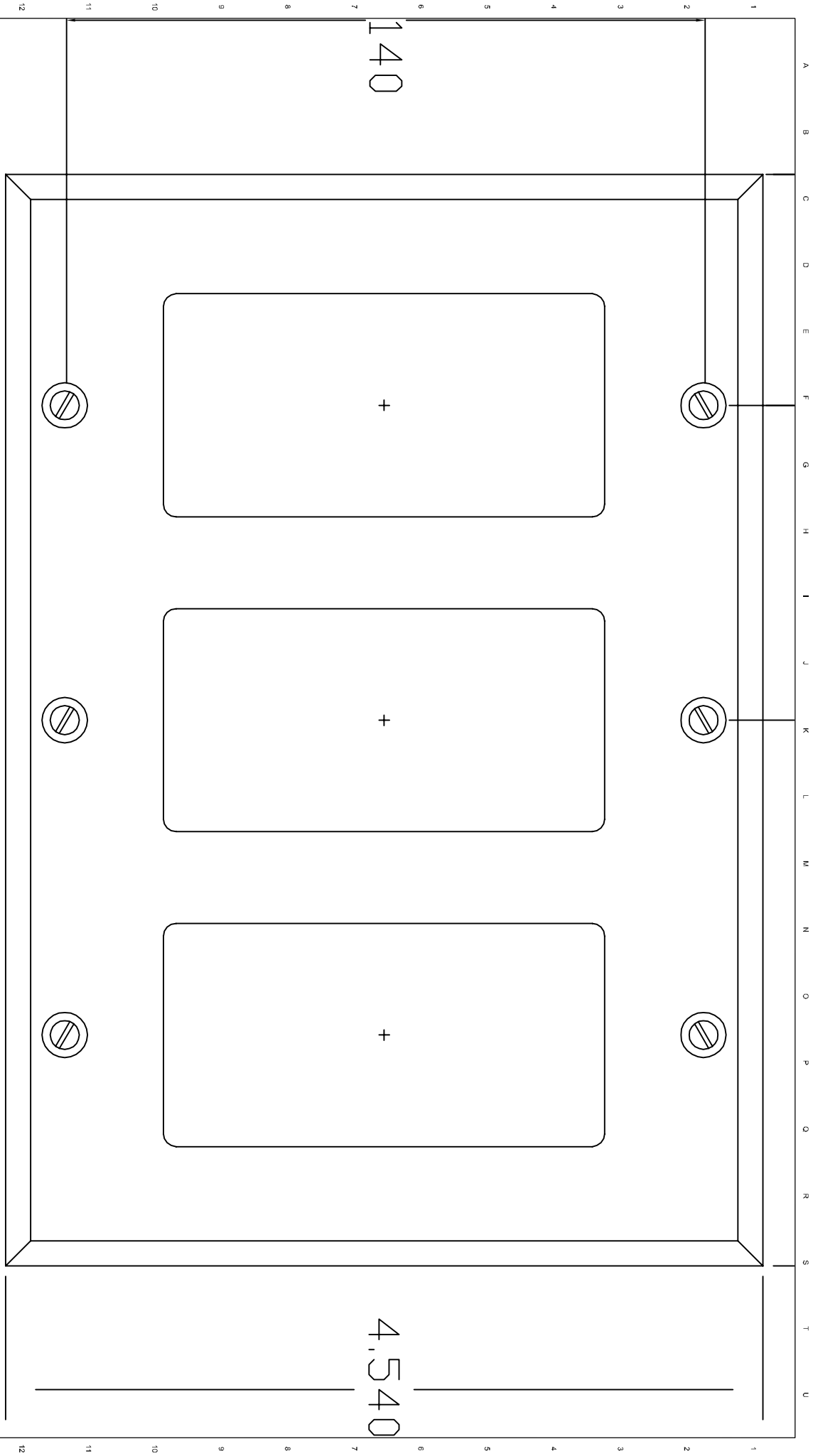

1.40

4.540

5003 THREE GANG FACEPLATE

FILENAME: PART NUMBER: 5003



Pathway Connectivity Inc.
 480C - 36 Avenue S.E.
 Calgary, Alberta, T2G 1W4, Canada
 Phone: +1(403)243-8110 Fax: +1(403)287-1281
<http://www.pathwayconnect.com>

DRAWN BY:	
DATE:	
CHECKED:	
SCALE:	NTS
UNITS:	INCHES

REV

A B C D E F G H I J K L M N O P Q R S T U

1 2 3 4 5 6 7 8 9 10 11 12 13

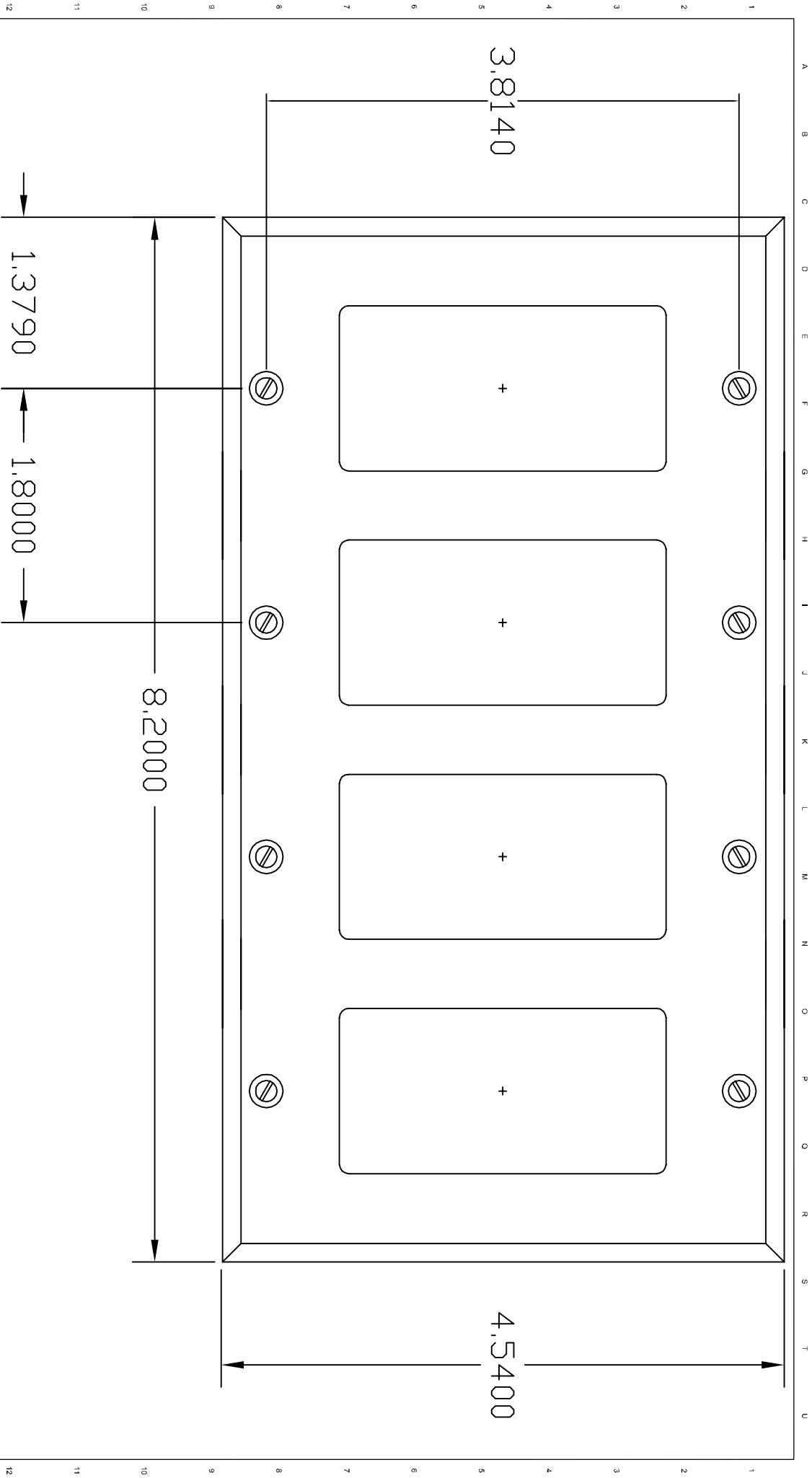

3.8140

+

+

+

+

4.5400

8.2000

1.3790

1.8000

5004 FOUR GANG FACEPLATE

FILENAME: PART NUMBER: 5004



Pathway Connectivity Inc.
 480C - 36 Avenue S.E.
 Calgary, Alberta, T2G 1W4, Canada
 Phone: +1(403)243-8110 Fax: +1(403)287-1281
<http://www.pathwayconnect.com>

DRAWN BY:	
DATE:	
CHECKED:	
SCALE:	NTS
UNITS:	INCHES

REV

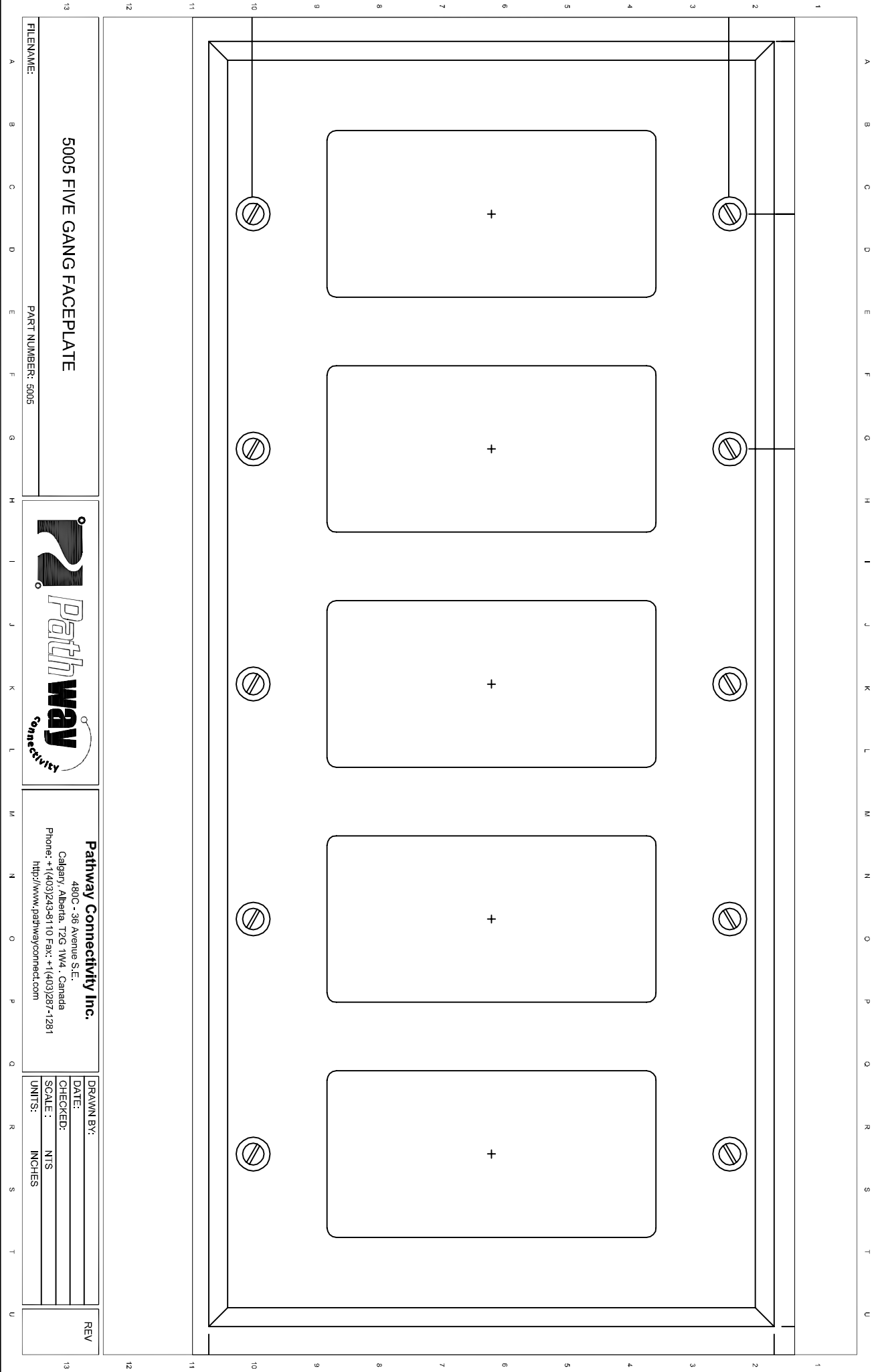

5005 FIVE GANG FACEPLATE

FILENAME: PART NUMBER: 5005



Pathway Connectivity Inc.
 480C - 36 Avenue S.E.
 Calgary, Alberta, T2G 1W4, Canada
 Phone: +1(403)243-8110 Fax: +1(403)287-1281
<http://www.pathwayconnect.com>

DRAWN BY:	
DATE:	
CHECKED:	
SCALE:	NTS
UNITS:	INCHES

REV

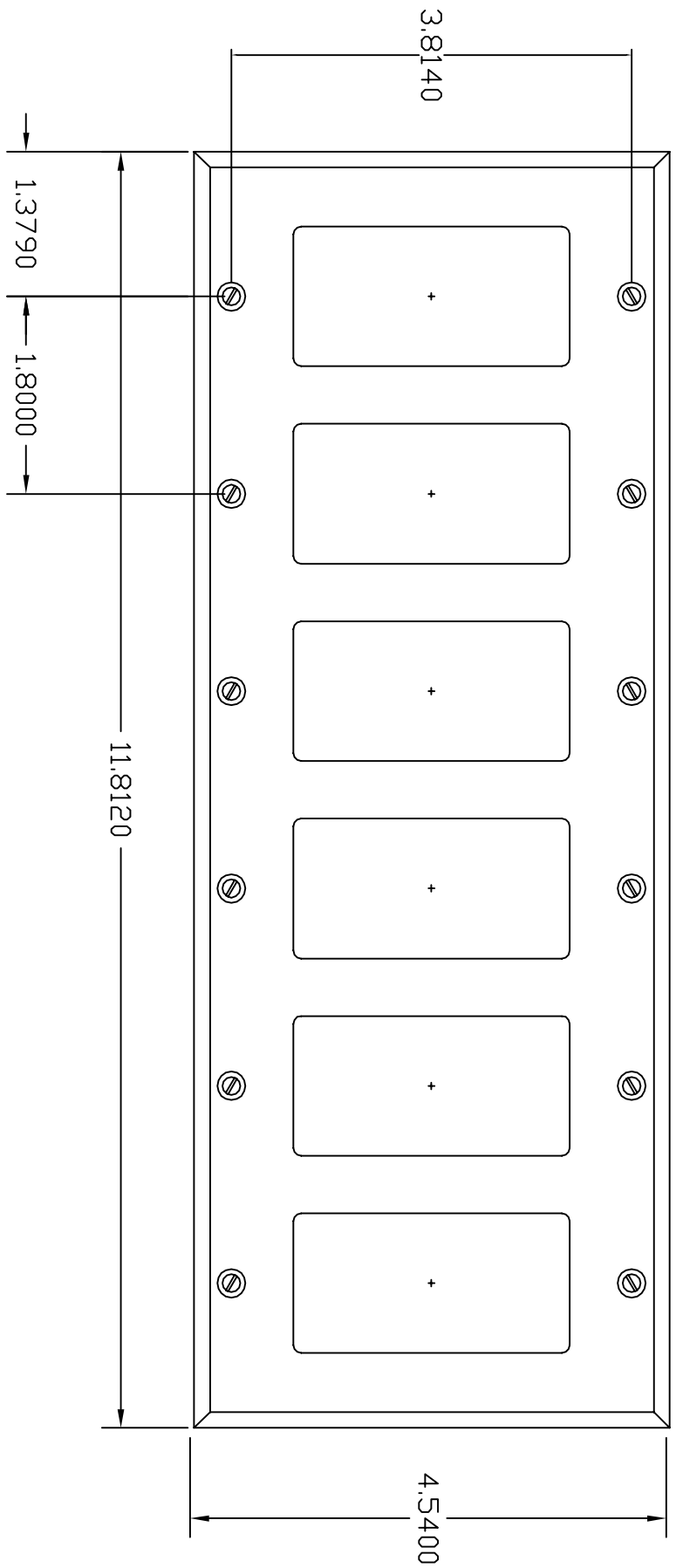

5006

5006 SIX GANG FACEPLATE

FILENAME: PART NUMBER: 5006



Pathway Connectivity Inc.
 480C - 36 Avenue S.E.
 Calgary, Alberta, T2G 1W4, Canada
 Phone: +1(403)243-8110 Fax: +1(403)287-1281
<http://www.pathwayconnect.com>

DRAWN BY:	
DATE:	
CHECKED:	
SCALE:	NTS
UNITS:	INCHES

REV